

For the perfect finish





GT "B" SET - Most universal set. Accepts all "B" type blades.

EL1100GT



Includes:

- ▲ Blade Holder *EL0103GT* which telescopes from 6-125mm. Holds all "B" (Ø2.6mm) blades.
- ▲ One each *GT-B10* and *GT-B20* HSS blade inside the Handle.
- ▲ Universal Handle *EL1000GT* which can store spare blades.



GT "E" SET - This set is similar to the GT "B" Set but takes the heavy-duty "E" (Ø 3.2mm) blades.

EL1200GT



Includes:

- ▲ Blade Holder *EL0200GT* which telescopes from 6-125mm. Holds all "E" (3.2mm) blades.
- ▲ One each *GT-E100*, *GT-E200*, *GT-E300* HSS blade.
- ▲ Universal Handle *EL1000GT* which can store blades.



GT-COUNTERSINK - For deburring and countersinking. Most useful for deep holes.

EL1300GT



Includes:

- ▲ Blade Holder *EL0300GT*. Holds all "C" Countersinks.
- ▲ H.S.S Ø 20mm, *GT-C20* HSS Countersink.
- ▲ Universal Handle *EL1000GT*.



GT-KEYWAY-BURR - For deburring narrow or wide slots. Internal and external keyways.

EL1400GT



Includes:

- ▲ Blade Holder *EL0400GT*. Holds all "N" keyways blades.
- ▲ One *GT-N80K* HSS blade.
- ▲ Universal Handle *EL1000GT*.



GT-TRIANGULAR SCRAPER for standard scraping
EL1601GT



safety cap



Includes:

- ▲ Blade Holder *EL0602GT* with NF#10 internal thread.
- ▲ Triangular HSS scraper *GT-T60* with NF#10 external thread and plastic safety cap.
- ▲ Universal Handle *EL1000GT*.



GT-MEDIUM TRIANGULAR SCRAPER
EL1600GT



safety cap



Includes:

- ▲ Blade Holder *EL0602GT* with NF#10 internal thread.
- ▲ Triangular HSS scraper *GT-T40* with NF#10 external thread and plastic safety cap.
- ▲ Universal Handle *EL1000GT*.



GT-MINI SCRAPER Ideal for Tool & Die makers
EL1500GT



1.5mm Hex.
Key. *ELDK10GT*.



Includes:

- ▲ Blade Holder *EL0500GT*.
- ▲ Hollow ground HSS mini scraper *GT-D50* blade.
- ▲ Universal Handle *EL1000GT*.



GT-INTERNAL SCRAPER For deburring cross holes
EL1501GT



1.5mm Hex.
Key. *ELDK10GT*.



Includes:

- ▲ Blade Holder *EL0500GT*. An M3 setscrew is holding the blade.
- ▲ 45° HSS scraper *GT-D66* blade.
- ▲ Universal Handle *EL1000GT*.



HEAVY DUTY RotoDrive COUNTERSINK "GT Roto" - Reduces wrist fatigue, continuous rotation enables fast chamfering.
EL7500GT Patented



Includes:

- ▲ Blade Holder RD9000GT accept *GT-C12*, *GT-C20*, *GT-C30*.
- ▲ Ø 20mm HSS countersink *GT-C20*.
- ▲ Universal Handle *EL1000GT*.



SLOT CLEANER "GT-C" For the relieve corners of narrow slots. Down to 4 mm.

EL1705GT



Includes:

- ▲ Blade Holder *EL-0701GT*. Holds all "L" type blades except *GT-L1* blade.
- ▲ Corner relieve HSS blade *GT-L5*.
- ▲ Universal Handle *EL1000GT*.



GRAT-TEC "V" CUT For sheet metal range 1-8mm.

EL1703GT



Includes:

- ▲ Blade Holder *EL-0701GT*. Holds all "L" type blades except *GT-L1* blade.
- ▲ HSS Blade *GT-L3* for sheet metal deburring.
- ▲ Universal Handle *EL1000GT*.
- ▲ Handguard available upon request.



GRAT-TEC DOUBLE-BURR Simultaneously removes burrs from both sides of sheet metal

DB2000GT



- Includes:**
- ▲ Handle with special hand guard.
 - ▲ 2 pcs. HSS round blades *GT-N80*.



ADJUSTABLE SCRAPER Ideal for scraping, trimming and deburring almost all materials.

SC8000GT



Includes:

- ▲ 12mm anodized handle
- ▲ T80 double ended triangular scraper



GRAT-TEC SET-K
EL6000GT

Most universal deburring tool. From light to heavy-duty work. With large storage space for spare blades. Holds all "E" type blades.



Includes:

- ▲ Non-telescoping Handle with steel bushing EL2100GT.
- ▲ One each HSS blade GT-E100, GT-E200, GT-E300



GRAT-TEC RotoDrive "GT-U" For fast effective chamfering and countersinking.
EL6500GT

Patented.



Includes:

- ▲ Non-telescoping Handle with steel bushing EL2100GT.
- ▲ RotoDrive Ø16.5mm HSS Countersink, GT-BC1650.



RAPID-BURR
RB1000GT

Slim grip Aluminum Handle with one replaceable blade GT-E100.



Includes:

- ▲ 12mm Hexagonal painted handle. Holds all Ø3.2mm "E" type blades.
- ▲ One HSS blade GT-E100.



EDGE-OFF
EO1000GT

Low price disposable tool. Can deburr almost every job on Aluminum and steel.



Includes:

- ▲ 8mm Hexagonal painted handle with pocket clip.
- ▲ One HSS blade GT-E100 fixed to the Handle.



PLASTIC EDGE-OFF Most competitive tool. The blade is replaceable.
EO2000GT



Includes:

- ▲ 8mm Hexagonal plastic handle with pocket clip.
- ▲ One HSS Blade GT-E100.



GRAT-TEC BURR

NB1108GT

GT-E200S



Great all-around Deburring tool

- Includes:**
- ▲ Grattec Burr Handle NB1000GT.
 - ▲ GT-E100S Cobalt blade.
 - ▲ GT-E200S Cobalt blade.



ROTODRIVE COUNTERSINK

RD1040GT



The quickest way to chamfer by hand

- Includes:**
- ▲ Grattec Burr Handle NB1000GT.
 - ▲ RotoDrive Countersink GT-BC1040.
 - ▲ Range: 0-10.4mm.



EXTERNAL COUNTERSINK

RD4000GT



Chamfers the O.D on bars and tubes range 4-18mm

- Includes:**
- ▲ Grattec Burr Handle NB1000GT.
 - ▲ External RotoDrive HSS countersink GT-EX2000.
 - ▲ Range - 4-18mm



"O" RING BURR

KW2000GT



Removes burrs from internal O ring grooves 0-3mm

- Includes:**
- ▲ Grattec Burr Handle NB1000GT.
 - ▲ "O" ring burr HSS blade GT-BO1000.



INTERNAL THREAD CLEANER

TC1000GT



Removes burrs and cleans internal threads

- Includes:**
- ▲ Grattec Burr Handle NB1000GT.
 - ▲ Internal thread cleaner HSS blade GT-BC1000.



LARGE REVERSIBLE COUNTERSINK For deburring both back and front sides of holes.
RC2200GT Patented



Includes:

- ▲ Steel handle and blade *GT-BR2200*.
- ▲ Range: 10-22mm.

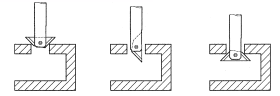

REVERSIBLE COUNTERSINK For deburring both back side and front side of holes.
RC2000GT Patented



Includes:

- ▲ Steel handle and blade *GT-BR2000*.
- ▲ Range: 5.5-10mm.



MINI REVERSIBLE COUNTERSINK For deburring both back side and front side of holes.
RC1000GT Patented



Includes:

- ▲ Steel handle and small blade *GT-BR1000*.
- ▲ Range: 3-5.5mm.



ADJUSTABLE MINI SCRAPER The best mini scraper for tool and die makers.
YT1100GT



Includes:

- ▲ YT Handle *YT1000GT*.
- ▲ D75 H.S.S. triangular mini scraper .Size: 75x3.2mm (GT-D75)



ADJUSTABLE SCRAPER Ideal for scraping, trimming and deburring almost all materials.
YT1200GT



Includes:

- ▲ YT Handle *YT1000GT*
- ▲ T80 double ended triangular medium scraper. Size: 80x4.5mm (GT-T80).



SOFT GRIP BURR Ergonomically held Handle with soft grip. Accepts both heavy and light duty "E" & "B" Blades due to 2 holes.
SG1000GT



TO INSERT BLADE:

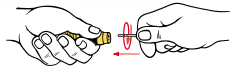

1. Hold handle in left hand and blade in right hand.
2. Push blade in and turn clockwise simultaneously.

TO REMOVE BLADE: Repeat as above but pull out.

Includes:



- ▲ Ergonomically held handle with soft grip (SG3000GT)
- ▲ One Cobalt (M35) heavy duty Blade GT-E100S, One Cobalt (M35) light duty Blade GT-B10S.



PLASTIC RAPID BURR

Holds all "E" blades (3.2mm). The blade is replaceable.
RB1401GT

RB1401GT



Includes:

- ▲ Plastic handle and E100 blade.



MINI ROTODRIVE COUNTERSINK

FT1200GT

Deburs and countersinks small holes 0-3.0 mm Dia.



MINI SCRAPER

FT1100GT

Fine triangular HSS mini-scraper ideal for Tool and Die maker.



MINI-SET "GT-MINI"

FT3000GT

A set containing the three mini tools shown here.



MINI-UNIVERSAL DEBURRING TOOL

FT1000GT

A tool with finest HSS blade GT-E150 for extra fine jobs.





SOFT GRATCUT TOOL

EL5065GT



Ideal for deburring soft abrasive plastics.

Includes:

▲ GratCut handle EL5000GT and GratCut blade 65° CR60001



HARD GRATCUT TOOL

EL5075GT



Ideal for deburring hard abrasive plastics.

Includes:

GratCut handle EL5000GT and GratCut blade 75° CR61001



CERA-CUT

CR1100GT



Ideal for deburring plastics and other soft materials. Extremely long life. The blade is not replaceable.

Includes:

Ceramic blade with convex radius $R=250\text{mm}$, mounted in ergonomically Soft Grip handle.

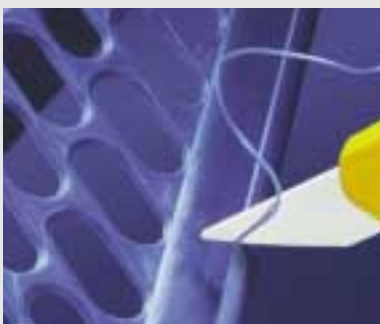

CONVEXED CERA-CUT

CR2000GT



Ideal for all plastic materials. Suitable for surface scraping and parting line deflashing. Blade can be replaced.

Includes:

Cera-Cut handle and ceramic blade with radius $R=250\text{mm}$.



CERAMIC DOUBLE BURR

DB5000



Ideal for deburring both sides of a workpiece simultaneously. Blade can be replaced. Range: 1-11 mm.

Includes:

V-shaped ceramic blade mounted in ergonomically designed DB handle with safety guard to protect your hand.

ECONOMY SET NB1200GT1



Includes:

- ▲ Grattec Burr Handle and 20pcs. E100 Blades.
- ▲ The set comes in an attractive blister pack.

YT SCRAPER SET YT2000GT1



A combination of two scrapers and one NEW YT handle creates world's best scraper set.

Includes:

- ▲ Most economical set.
- ▲ Ideal for machinists and tool/die makers.
- ▲ A unique new YT handle (YT1000GT) fits into every hand.
- ▲ Hollow ground H.S.S. D75 (GT-D75) triangular adjustable mini scraper.
- ▲ T80 (GT-T80) double ended triangular adjustable scraper.

SOFT GRIP SET SG2000GT1

Includes:

- ▲ Ergonomically held handle with soft grip SG3000GT
- ▲ 21pcs. Cobalt (M35) heavy duty Blades (GT-E100S)
- ▲ 1pc. Cobalt (M35) light duty Blades (GT-B10S)



SOFT GRIP SET

SG2001GT1

Includes:

- ▲ Ergonomically held handle with soft grip SG3000GT
- ▲ 11pcs. Cobalt (M35) heavy duty Blades (GT-E100S)
- ▲ 11pc. Cobalt (M35) light duty Blades (GT-B10S)

"B" TELE SET EL8300GT

Includes:

- ▲ Universal handle (EL1000GT)
- ▲ "B" Blade Holder (EL0103GT)
- ▲ 5pcs. B10 and 5pcs. B20 light duty Blades.



"E" TELE SET

EL8350GT

Includes:

- ▲ Universal handle (EL1000GT)
- ▲ "E" Blade Holder (EL0200GT)
- ▲ 5pcs. E100 and 5pcs. E200 heavy duty Blades.

GRATTEC

DIAMOND AND SCRAPERS SET *YT3000GT*

This set is used in a variety of applications where fine and accurate work is necessary. The diamond files are manufactured in 5 popular profiles. The dimensions and its compact package enable the user to hold it for immediate use.

Includes:

- ▲ YT1000GT Handle.
- ▲ GT-D75 and GT-T80 Scrapers blades.
- ▲ 5 Diamond needle files: Round, Half Round, Square, Flat and Triangle.
- ▲ Total length of each file is 140mm.
- ▲ Diamond coated length is 70mm.
- ▲ Grit Size: D126.
- ▲ Shank Ø 3mm.



GRAT-TEC MRO SET *SP1010GT*

Deburring, cleaning, finishing, countersinking and scraping. New feature - Rapid Burr handle can hold swivel blades and scraper blades.

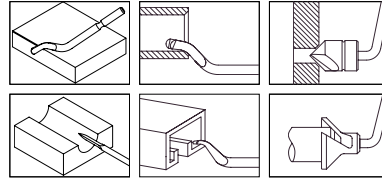

Includes:

- ▲ D50 (GT-D50)
- ▲ E150 Blade (GT-E150)
- ▲ RD16.5 (GT-BC1650)
- ▲ E100S Blade (GT-S100S)
- ▲ EX18 (GT-EX2000)
- ▲ E200 (GT-E200)
- ▲ RB handle



SUPER SET *RB4000GT*

The handle can hold both types of blades rotating and fixed. The set includes best popular blades

Includes:

- ▲ RB Handle
- ▲ GT-E100 & GT-D50 Blades



GRAT-TEC MINI SET *EL5100GT*

Combines the "E" Set and "B" Set into one kit



Includes:

- ▲ GRAT-TEC Universal Handle
- ▲ "E" Blade Holder
- ▲ "B" Blade Holder
- ▲ E100 Blade
- ▲ E200 Blade
- ▲ E300 Blade
- ▲ B10 Blade
- ▲ B20 Blade
- ▲ B30 Blade

The adjustable blade holder telescopes from 6mm to 125mm. Spare deburring blades can be stored in the Handle. Lifetime warranty against breakage.

GRAT-TEC BOX

EL2000GT

Take advantage of the whole, efficient GRAT-TEC system and save money at the same time, with this Handy Kit.



Includes:

- ▲ Double Burr DB2000GT
- ▲ Universal Handle EL1000GT
- ▲ Blade Holder EL0103GT
- ▲ Blade Holder EL0200GT
- ▲ Blade Holder EL0300GT+GT-C20
- ▲ Blade Holder EL0400GT+GT-N80K
- ▲ Blade Holder EL0500GT+GT-D50
- ▲ Blade Holder EL0500GT+GT-D66
- ▲ Hex Key 1.5mm GT-DH0005
- ▲ Countersink Blade 12mm GT-C12
- ▲ One each blade: GT-B10, GT-B20, GT-E100, GT-E200, GT-E300

GRAT-TEC 7 UP KIT

SP1700GT

A collection of 7 popular tools at one easy to carry box. Provides solutions for most deburring applications.



- ▲ GT-Countersink EL1300GT
- ▲ GT-Medium Triangular scraper EL1600GT
- ▲ GT "B" Set EL1100GT
- ▲ Rapid Burr RB1000GT
- ▲ GT-Keyway Burr EL1400GT
- ▲ "E" set EL1200GT
- ▲ GT- Internal Scraper EL1501GT

HANDLES

PLASTIC REAMER

SP81003



Deburr both inside and outside edges of tubes. Have 3 cutters. Reamer for aluminum, brass and copper tubing. Made of plastic. Range: 4-42mm

YT1000GT



The perfect grip on: Grattec adjustable scrapers, Needle files, Pins, Drills. Quick change, Fits every hand, Flexible collet. Range: 2.2-4.5mm

NB1000GT



A unique handle with large storage space for spare blades. Better grip. Safety button for quick change of blades. Holds all "E" Blades.

SG3000GT



Ergonomically held Handle with soft grip. Accepts both heavy and light duty "E" & "B" Blades due to 2 holes.

EL5000GT



New GratCut Handle. Can hold GratCut blades only CR60001 & CR61001.

EL2100GT



Solid and non-telescoping with steel bushing. Holds all "E" 3.2mm Blades. Has large storage space for spare blades.

EL1000GT



Universal Handle, holds all GRATTEC blade holders. With large storage space for spare blades.

HOLDERS

B Holder

EL0100GT

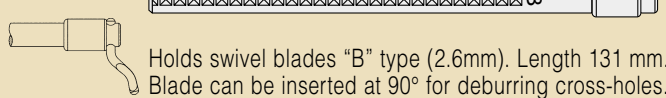

Holds swivel blades "B" type (2.6mm). Length 131 mm. Blade can be inserted at 90° for deburring cross-holes.

B Holder

EL0103GT



Holds swivel blades "B" type (2.6mm). Length 131 mm.

E Holder

EL0200GT



Holds swivel blades "E" type (3.2mm). Length 131mm.

C Holder

EL0300GT



Holds "C" type countersinks. With M7 internal thread.

K Holder

EL0400GT



Holds "N" type keyway blades with M3 thread.

D Holder

EL0500GT

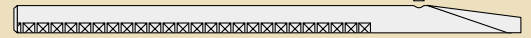

Holds GT-D50 and GT-D66 scrapers. An 3mm setscrew is holding the blade

T Holder

EL0602GT

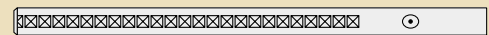

Holds GT-T40 and GT-T60 scrapers. Has internal thread NF#10.

L Holder

EL0750GT

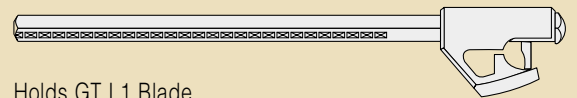

Holds GT L1 Blade.

EL0701GT

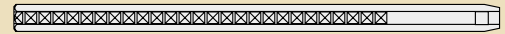

Blades are held in a 3mm square hole and tightened with 4mm set screw. Holds GT-L3, GT-L4, GT-L5, GT-L6 and GT-L7.

RD9000GT































H.D. RotoDrive Holder - RD9000GT Heavy duty cranked holder. External M7 thread to hold C12, C20 and C30 countersinks. 40mm displacement

RD9500GT







H.D. Ext. RotoDrive Holder - RD9500GT Heavy duty cranked holder for ext. countersink. Accepts RDE28 external countersink. 40mm displacement.



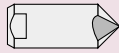
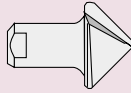
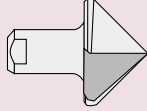



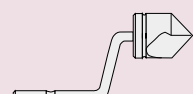
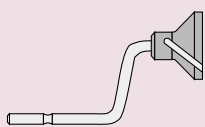
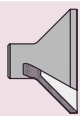

SWIVEL BLADES

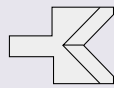
GT-B10		HSS blade light duty for steel, aluminum and plastic.
GT-B10L		B10 for left handed user.
GT-B10S		Super hard B10 Cobalt (M35) Blade for stainless steel and plastics
GT-B10TIN		B10 Tin coated for long life.
GT-B10D		B10 Diamond coated for ceramic and glass.
GT-B10C		Solid carbide B10 blade for hardened steel and plastic.
GT-B20		HSS blade light duty for brass and cast iron. For both right & left handed users.
GT-B20C		Solid carbide B20 blade for hardened steel and hard plastics.
GT-B30		HSS blade removes internal and external burrs simultaneously from holes drilled into tubing and sheet metal.
GT-B60		HSS blade for cross holes in difficult to reach places.
GT-E100		HSS blade heavy duty for steel, aluminum and plastic.
GT-E100L		E100 for left handed users.
GT-E100TIN		E100 TiN coated for long life.
GT-E100D		E100 Diamond coated for ceramic and glass.
GT-E100C		Solid carbide E100 blade for hardened steel and plastic.
GT-E100S		Super hard E100 cobalt (M35) Blade for stainless steel and Plastics.
GT-E101		H.S.S blade with heavy duty shank and fine cutting edge for steel and aluminum.
GT-E101L		E101 for left handed users.
GT-E101TIN		E101 TiN coated for long life.
GT-E150		HSS blade heavy duty shank for holes as small as 1.5 mm Dia.
GT-E200		HSS blade heavy duty for brass and cast iron For both right & left handed users.
GT-E200C		Solid carbide E200 blade for hardened materials and plastics.
GT-E202		HSS blade heavy duty shank. Fine cutting edge for brass and cast iron.
GT-E300		HSS blade heavy duty. Removes internal and external burrs simultaneously from holes drilled into tubing and sheet metal.
GT-E350		HSS blade. Heavy duty for straight lines.
GT-E600		HSS blade. Heavy duty for cross holes in difficult to reach places.
GT-BC1000		Patented HSS blade. For deburring and cleaning internal threads above 9mm Dia.
GT-BO1000		Patented H.S.S blade for deburring "O" Ring grooves up to 3mm width.





COUNTERSINKS

GT-C12		HSS Ø12 mm 90° two flutes countersink.
GT-C20		HSS Ø20 mm 90° two flutes countersink.
GT-C30		HSS Ø30 mm 90° two flutes countersink.
GT-BC3200		Patented cranked HSS RotoDrive countersink 0-3mm.
GT-BC6300		Patented cranked HSS RotoDrive countersink 0-6.3mm.
GT-BC8300		Patented cranked HSS RotoDrive countersink 0-8.3mm.
GT-BC1040		Patented cranked HSS RotoDrive countersink 0-10.4mm.
GT-BC1650		Patented cranked HSS RotoDrive countersink 0-16.5mm.
GT-EX2000		Patented cranked HSS external countersink 4-18mm.
GT-EX30011		Patented cranked HSS. 28mm external Countersink. - Range 8-28mm.



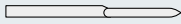
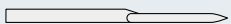
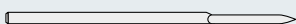



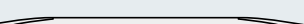





L and BR – BLADES

GT-L1		For 45° chamfer on straight or curved edge.
GT-L3		For sheet metal 1-8mm wide.
GT-L4		For small ridges 0-2.5mm wide.
GT-L5		For cleaning narrow slots from 5mm.
GT-L6		For cleaning corners.
GT-L7		double ended slot cleaner.
GT-BR2200		For cross holes 10-22mm. HSS Blade for RC2200GT.
GT-BR2000		For cross holes 5.5-10mm. HSS Blade for RC2000GT.
GT-BR1000		For cross holes 3-5.5mm. HSS Blade for RC1000GT.

SCRAPERS

GT-D50		HSS Hollow ground mini scraper 3.2 x 50mm. For very fine jobs. Used with D Holder <i>EL0500GT</i> .
GT-D55		Solid carbide <i>GT-D50</i> . Used with D Holder <i>EL0500GT</i> .
GT-D75		Similar to D50 but 75mm long. Used with D Holder <i>EL0500GT</i> .
GT-T40		5 x 40mm HSS triangular scraper used with T Holder <i>EL0602GT</i> .
GT-T60		7 x 60mm HSS triangular scraper used with T Holder <i>EL0602GT</i> .
GT-D66		3.2 x 50mm 45° H.S.S internal scraper for cross holes. Used with D Holder <i>EL0500GT</i> .
GT-D77		Similar to D66 but 75mm long. Used with D Holder <i>EL0500GT</i> .
GT-T80		80X4.5mm double ended triangular scraper.

GT-N BLADES

GT-N80			HSS round blade used for double burr. Cut along full circumference of both sides.
GT-N80M42			Similar to <i>N80</i> but made out of <i>M42</i> for extra hardness. Used on stainless steel.
GT-N70K			HSS for small keyways 1.2-8mm has 8 cutting edges. Truncated corner for shallow keyways.
GT-N80K			HSS the standard keyway blade. Range 2.4-11mm
GT-N80KM42			Similar to <i>N80K</i> but made out of <i>M42</i> for extra hardness.
GT-N90K			HSS similar to <i>N70K</i> but for larger keyway. Range 3-15mm.

GRATCUT SET CR5510GT

Ideal for deburring soft and hard abrasive plastics

Includes: ▲ 5pcs. GratCut Blades 65° (CR60001)
 ▲ 5pcs. GratCut Blades 75° (CR61001)
 ▲ Free GratCut Handle (EL5000GT)



CERAMIC BLADES

CONVEXED BLADE

CR22001



Ideal for surface cleaning and parting line deflashing. Hardness 1250HV. Included angle 90deg.

CONCAVED BLADE

CR25001



Ideal for curved edges and small ridges. Hardness 1250HV. Included angle 90deg.

V SHAPED BLADE

CR51001



Removes burrs from both sides of a workpiece simultaneously. Hardness 1250HV. Included angle 90deg.

SOFT CUT BLADE (65°)

CR60001



Ideal for deburring soft abrasive plastics.

HARD CUT BLADE (75°)

CR61001

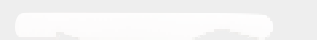

Ideal for deburring hard abrasive plastics

GRATTEC

ООО "Технотулс"

г. Москва

+7 (967) 121-85-70

www.tehno-ts.ru

info@tehno-ts.ru

